

Date: 230522

Sign. LJE

Scale: 1:50

No. T1 2433

UPLIFTING COMPANY

AUTOP STENHOJ

MagiX 50-52-S-P
recessed

Rev. date:

Note! Sketch is shown as standard version with 2 x recesses
- for further options see foundation drawing T82337

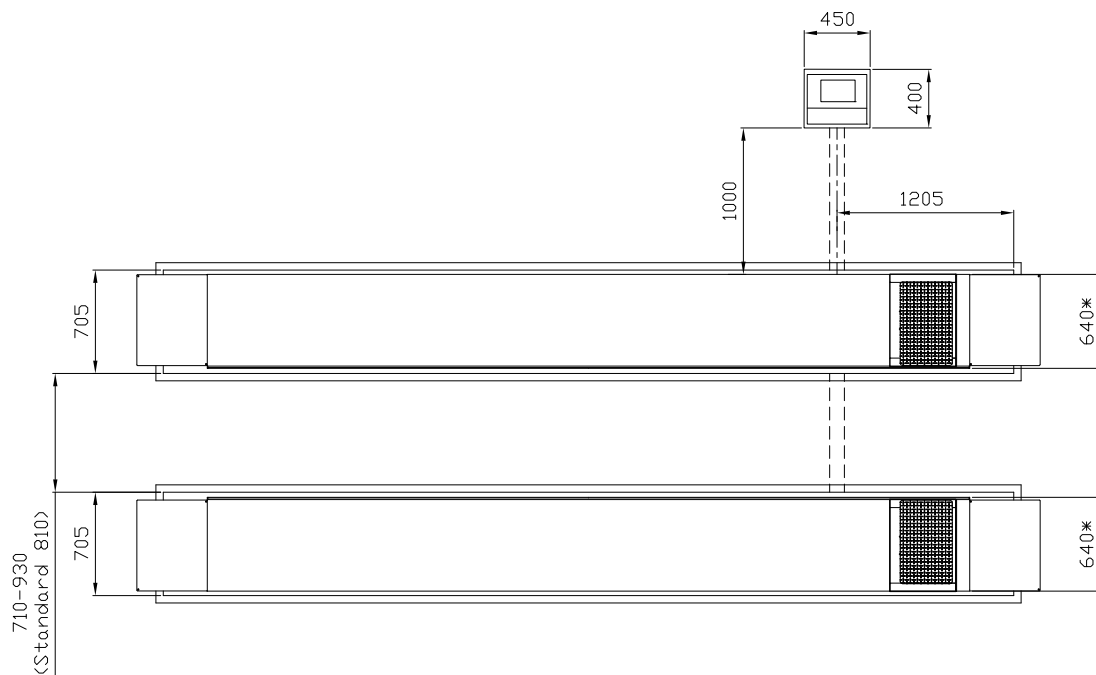
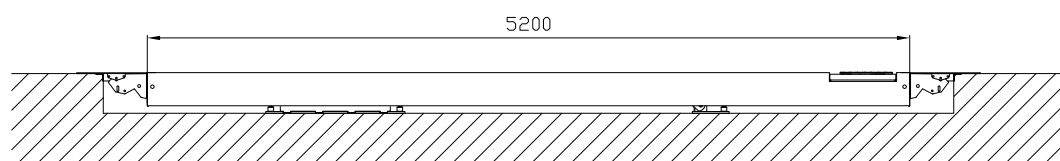
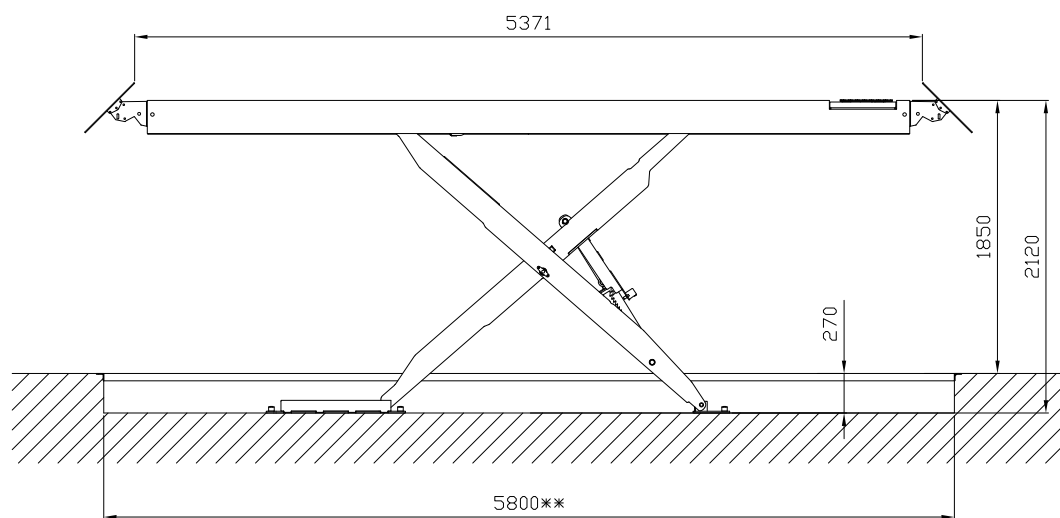

*) Guiding rails included.

***) Dimensions for recesses are identical for drive-on and drive-over versions